

TOSHIBA CMOS Linear Integrated Circuit Silicon Monolithic

TCR5SB15A~TCR5SB50A

150 mA CMOS Low-Dropout Regulator (Point Regulator)

The TCR5SB15A to TCR5SB50A are CMOS general-purpose single-output voltage regulators with an on/off control input, featuring low dropout voltage and low quiescent bias current. The TCR5SB15A to TCR5SB50A can be enabled and disabled via the CONTROL pin.

These voltage regulators are available in fixed output voltages between 1.5 V and 5.0 V in 0.1-V steps and capable of driving up to 150 mA. They feature overcurrent protection.

The TCR5SB15A to TCR5SB50A are offered in the compact SMV (SOT23-5) (SC-74A) and allow the use of small ceramic input and output capacitors. Thus, these devices are ideal for portable applications that require high-density board assembly such as cellular phones.

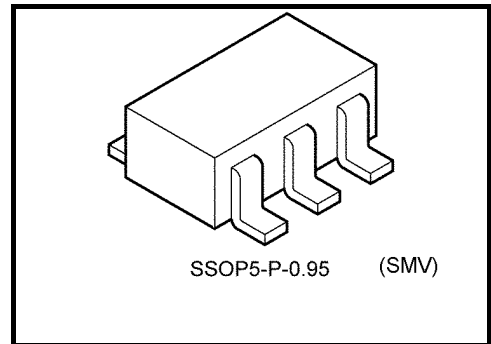

Weight: 0.014 g (typ.)

Features

- Low quiescent bias current ($I_B = 32 \mu\text{A}$ (typ.) at $I_{OUT} = 0 \text{ mA}$)
- Low stand-by current ($I_{B(OFF)} = 0.1 \mu\text{A}$ (typ.) at Stand-by mode)
- Low-dropout voltage ($V_{IN} - V_{OUT} = 90 \text{ mV}$ (typ.) at TCR5SB25A, $I_{OUT} = 50 \text{ mA}$)
- High ripple rejection ($R.R = 70 \text{ dB}$ (typ) at $I_{OUT} = 10 \text{ mA}$, $f = 1\text{kHz}$)
- Control voltage can be allowed from -0.3 to 6 V regardless of V_{IN} voltage.
- Overcurrent protection
- Ceramic capacitors can be used ($C_{IN} = 0.1 \mu\text{F}$, $C_{OUT} = 1.0 \mu\text{F}$)
- Wide range voltage listing (Please see Output Voltage Accuracy at page 4 for variety of the output voltage)
- Small package, SMV (SOT23-5) (SC-74A)

Pin Assignment (top view)

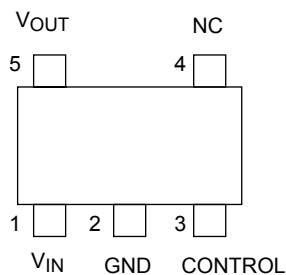

List of Products Number and Marking

Products No.	Marking	Products No.	Marking
TCR5SB15A	1G5	TCR5SB33A	3G3
TCR5SB16A	1G6	TCR5SB34A	3G4
TCR5SB17A	1G7	TCR5SB35A	3G5
TCR5SB18A	1G8	TCR5SB36A	3G6
TCR5SB19A	1G9	TCR5SB37A	3G7
TCR5SB20A	2G0	TCR5SB38A	3G8
TCR5SB21A	2G1	TCR5SB39A	3G9
TCR5SB22A	2G2	TCR5SB40A	4G0
TCR5SB23A	2G3	TCR5SB41A	4G1
TCR5SB24A	2G4	TCR5SB42A	4G2
TCR5SB25A	2G5	TCR5SB43A	4G3
TCR5SB26A	2G6	TCR5SB44A	4G4
TCR5SB27A	2G7	TCR5SB45A	4G5
TCR5SB28A	2G8	TCR5SB46A	4G6
TCR5SB29A	2G9	TCR5SB47A	4G7
TCR5SB30A	3G0	TCR5SB48A	4G8
TCR5SB31A	3G1	TCR5SB49A	4G9
TCR5SB32A	3G2	TCR5SB50A	5G0

Marking

Example: TCR5SB30A (3.0 V output)

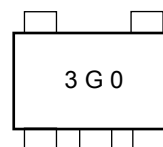

Absolute Maximum Ratings (Ta = 25°C)

Characteristics	Symbol	Rating	Unit
Input voltage	V_{IN}	6	V
Control voltage	V_{CT}	-0.3 to 6	V
Output voltage	V_{OUT}	-0.3 to $V_{IN} + 0.3$	V
Output current	I_{OUT}	150	mA
Power dissipation	P_D	200 (Note1)	mW
		380 (Note2)	
Operation temperature range	T_{opr}	-40 to 85	°C
Junction temperature	T_j	150	°C
Storage temperature range	T_{stg}	-55 to 150	°C

Note: Using continuously under heavy loads (e.g. the application of high temperature/current/voltage and the significant change in temperature, etc.) may cause this product to decrease in the reliability significantly even if the operating conditions (i.e. operating temperature/current/voltage, etc.) are within the absolute maximum ratings and the operating ranges.

Please design the appropriate reliability upon reviewing the Toshiba Semiconductor Reliability Handbook ("Handling Precautions"/"Derating Concept and Methods") and individual reliability data (i.e. reliability test report and estimated failure rate, etc).

Note 1: Unit Rating

Note 2: Rating at mounting on a board
(Glass epoxy board dimension : 30 mm × 30 mm, Copper pad area : 50 mm²)

Electrical Characteristics

(Unless otherwise specified,
 $V_{IN} = V_{OUT} + 1 \text{ V}$, $I_{OUT} = 50 \text{ mA}$, $C_{IN} = 0.1 \mu\text{F}$, $C_{OUT} = 1.0 \mu\text{F}$, $T_j = 25^\circ\text{C}$)

Characteristics	Symbol	Test Condition	Min	Typ.	Max	Unit	
Output voltage	V_{OUT}	Please refer to the Output Voltage Accuracy table					
Line regulation	Reg·line	$V_{OUT} + 0.5 \text{ V} \leq V_{IN} \leq 6 \text{ V}$, $I_{OUT} = 1 \text{ mA}$	—	1	15	mV	
Load regulation	Reg·load	$1 \text{ mA} \leq I_{OUT} \leq 100 \text{ mA}$	—	15	30	mV	
Quiescent current	I_B	$I_{OUT} = 0 \text{ mA}$	—	32	75	μA	
Stand-by current	I_B (OFF)	$V_{CT} = 0 \text{ V}$	—	0.1	1.0	μA	
Dropout voltage	$V_{IN} - V_{OUT}$	Please refer to the Dropout voltage table					
Temperature coefficient	T_{CVO}	$-40^\circ\text{C} \leq T_{opr} \leq 85^\circ\text{C}$	—	100	—	ppm/ $^\circ\text{C}$	
Input voltage	V_{IN}	—	TCR5SB15A	2.0	—	6.0	V
			TCR5SB16A to TCR5SB17A	2.1	—	6.0	
			TCR5SB18A to TCR5SB19A	$V_{OUT} + 0.35 \text{ V}$	—	6.0	
			TCR5SB20A to TCR5SB21A	$V_{OUT} + 0.28 \text{ V}$	—	6.0	
			TCR5SB22A to TCR5SB24A	$V_{OUT} + 0.25 \text{ V}$	—	6.0	
			TCR5SB25A to TCR5SB50A	$V_{OUT} + 0.20 \text{ V}$	—	6.0	
Ripple rejection ratio	R.R.	$V_{IN} = V_{OUT} + 1 \text{ V}$, $I_{OUT} = 10 \text{ mA}$, $f = 1 \text{ kHz}$, $V_{Ripple} = 500 \text{ mV}_{p-p}$, $T_a = 25^\circ\text{C}$	—	70	—	dB	
Control voltage (ON)	V_{CT} (ON)	—	1.1	—	6.0	V	
Control voltage (OFF)	V_{CT} (OFF)	—	0	—	0.3	V	
Control current (ON)	I_{CT} (ON)	$V_{CT} = 6.0 \text{ V}$	—	—	0.1	μA	
Control current (OFF)	I_{CT} (OFF)	$V_{CT} = 0 \text{ V}$	—	—	0.1	μA	

Output Voltage Accuracy

($V_{IN} = V_{OUT} + 1\text{ V}$, $I_{OUT} = 50\text{ mA}$, $C_{IN} = 0.1\text{ }\mu\text{F}$, $C_{OUT} = 1.0\text{ }\mu\text{F}$, $T_j = 25^\circ\text{C}$)

Product No.	Symbol	Min	Typ.	Max	Unit
TCR5SB15A	V _{OUT}	1.47	1.5	1.53	V
TCR5SB16A		1.56	1.6	1.64	
TCR5SB17A		1.66	1.7	1.74	
TCR5SB18A		1.76	1.8	1.84	
TCR5SB19A		1.86	1.9	1.94	
TCR5SB20A		1.96	2.0	2.04	
TCR5SB21A		2.05	2.1	2.15	
TCR5SB22A		2.15	2.2	2.25	
TCR5SB23A		2.25	2.3	2.35	
TCR5SB24A		2.35	2.4	2.45	
TCR5SB25A		2.45	2.5	2.55	
TCR5SB26A		2.54	2.6	2.66	
TCR5SB27A		2.64	2.7	2.76	
TCR5SB28A		2.74	2.8	2.86	
TCR5SB29A		2.84	2.9	2.96	
TCR5SB30A		2.94	3.0	3.06	
TCR5SB31A		3.03	3.1	3.17	
TCR5SB32A		3.13	3.2	3.27	
TCR5SB33A		3.23	3.3	3.37	
TCR5SB34A		3.33	3.4	3.47	
TCR5SB35A		3.43	3.5	3.57	
TCR5SB36A		3.52	3.6	3.68	
TCR5SB37A		3.62	3.7	3.78	
*TCR5SB38A		3.72	3.8	3.88	
*TCR5SB39A		3.82	3.9	3.98	
*TCR5SB40A		3.92	4.0	4.08	
*TCR5SB41A		4.01	4.1	4.19	
*TCR5SB42A		4.11	4.2	4.29	
*TCR5SB43A		4.21	4.3	4.39	
*TCR5SB44A		4.31	4.4	4.49	
*TCR5SB45A	4.41	4.5	4.59		
*TCR5SB46A	4.50	4.6	4.70		
*TCR5SB47A	4.60	4.7	4.80		
TCR5SB48A	4.70	4.8	4.90		
*TCR5SB49A	4.80	4.9	5.00		
TCR5SB50A	4.90	5.0	5.10		

Please contact your local Toshiba representative if you are interested in products with * sign.

Dropout Voltage

($I_{OUT} = 50 \text{ mA}$, $C_{IN} = 0.1 \mu\text{F}$, $C_{OUT} = 1.0 \mu\text{F}$, $T_j = 25^\circ\text{C}$)

Product No.	Symbol	Min	Typ.	Max	Unit
TCR5SB15A to TCR5SB16A	V _{IN-VOUT}	—	300	500	mV
TCR5SB17A		—	250	400	
TCR5SB18A to TCR5SB19A		—	200	350	
TCR5SB20A to TCR5SB21A		—	150	280	
TCR5SB22A to TCR5SB24A		—	130	250	
TCR5SB25A to TCR5SB50A		—	90	200	

Application Note

1. Recommended Application Circuit

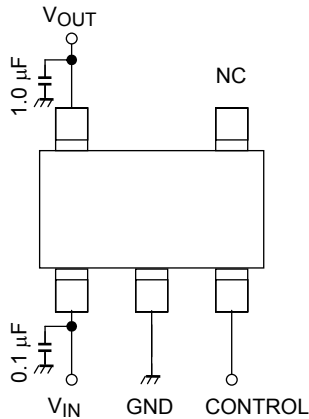

Control Level	Operation
HIGH	ON
LOW	OFF

The figure above shows the recommended configuration for using a Low-Dropout regulator. Insert a capacitor at V_{OUT} and V_{IN} pins for stable input/output operation. (Ceramic capacitors can be used)

If the control function is not used, Toshiba recommend that the control pin is connected to the V_{IN} pin.

2. Power Dissipation

Power dissipation is measured on the board shown below.

Testing Board of Thermal Resistance

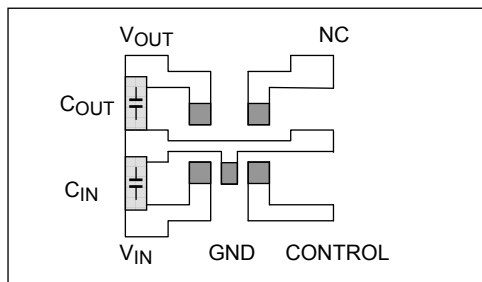

Board material: Glass Epoxy, Board dimension 30 mm × 30 mm
Copper area: 50 mm², t = 0.8 mm

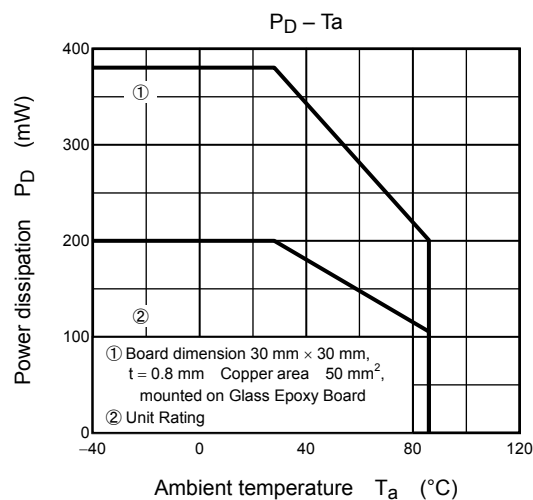

Attention in Use

- **Output Capacitors**
Ceramic capacitors can be used for these devices. However, because of the type of the capacitors, there might be unexpected thermal features. Please consider application condition for selecting capacitors. And Toshiba recommend the ESR of ceramic capacitor is under 10 Ω .
- **Mounting**
The long distance between IC and output capacitor might affect phase assurance by impedance in wire and inductor. For stable power supply, output capacitor need to mount near IC as much as possible. Also GND pattern need to be large and make the wire impedance small as possible.
- **Permissible Loss**
Please have enough design patterns for expected maximum permissible loss. And under consideration of surrounding temperature, input voltage, and output current etc, we recommend proper dissipation ratings for maximum permissible loss; in general maximum dissipation rating is 70 to 80 percent.
- **Overcurrent Protection Circuit**
Overcurrent protection circuit is designed in these products, but this does not assure for the suppression of uprising device operation. If output pins and GND pins are shorted out, these products might be break down. In use of these products, please read through and understand dissipation idea for absolute maximum ratings from the above mention or our 'Semiconductor Reliability Handbook'. Then use these products under absolute maximum ratings in any condition. Furthermore, Toshiba recommend inserting failsafe system into the design.

Representative Typical Characteristics

1) Output Voltage vs. Input Voltage

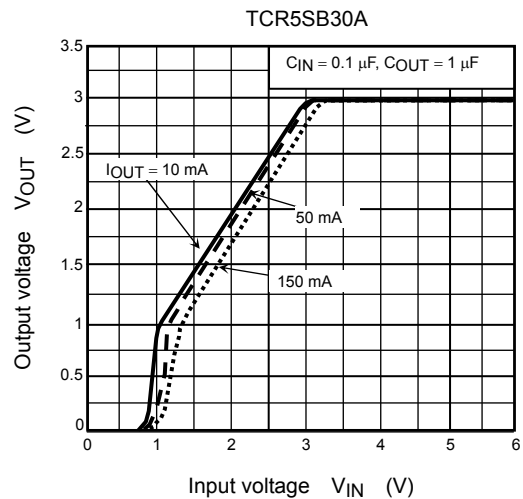
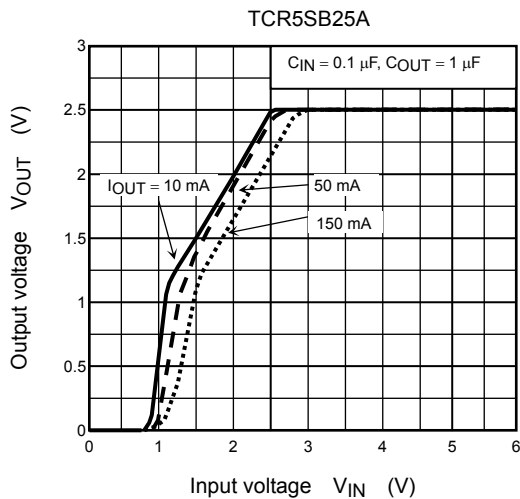
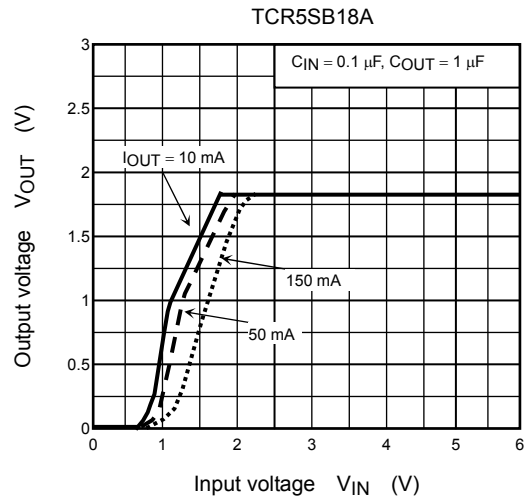
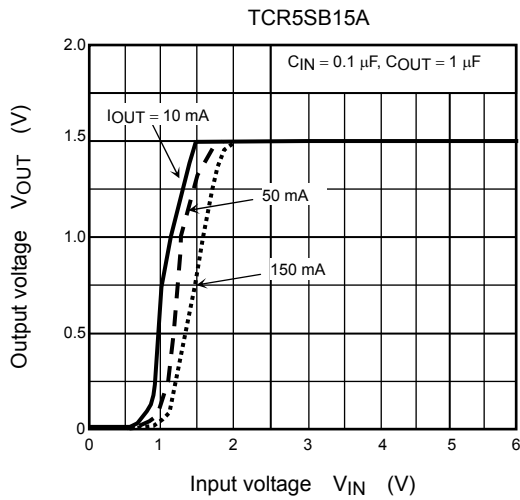

2) Output Voltage vs. Output Current

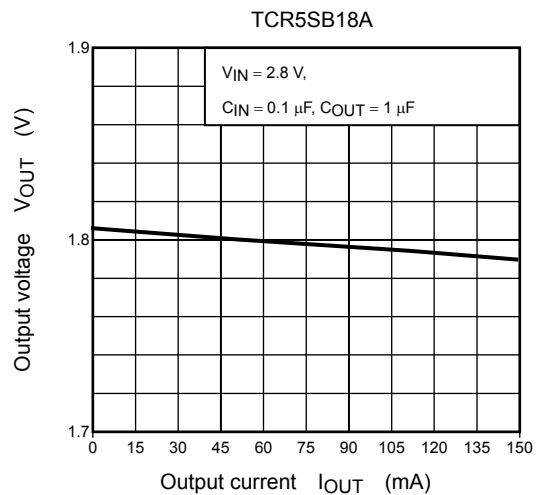
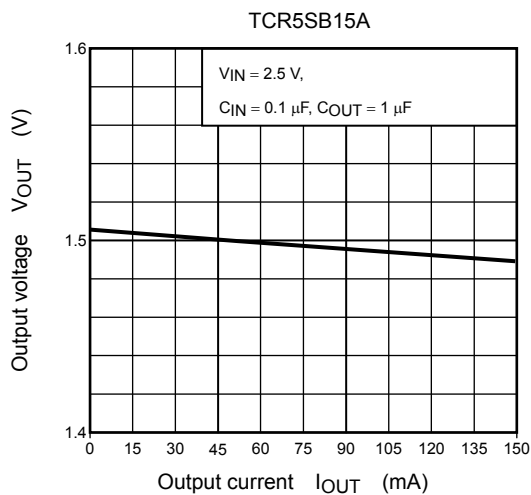

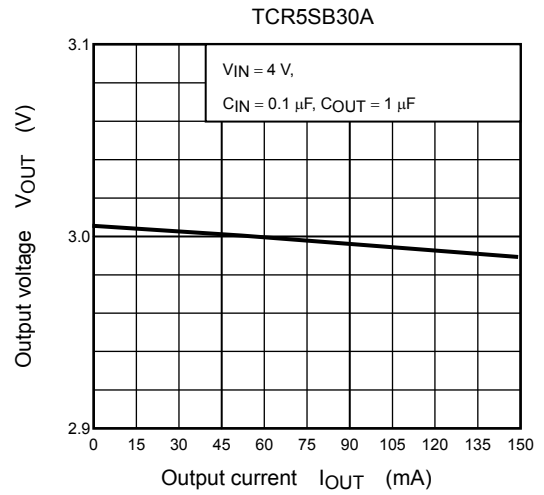
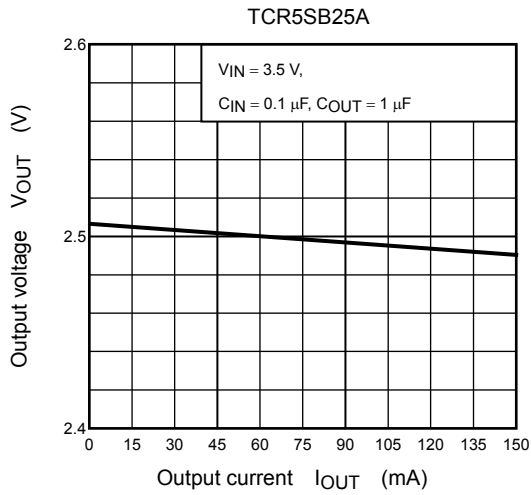

3) Output Voltage vs. Ambient temperature

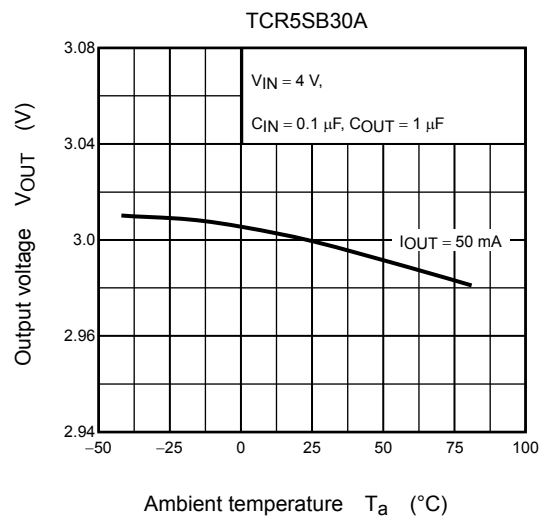
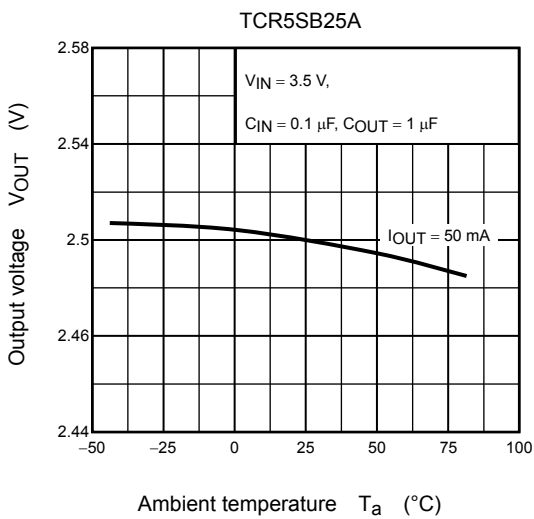
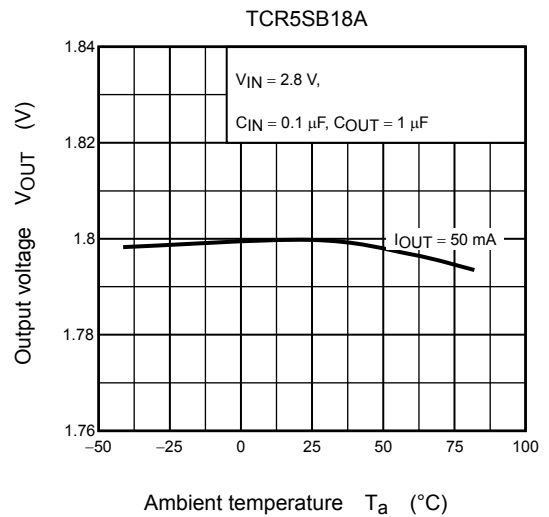
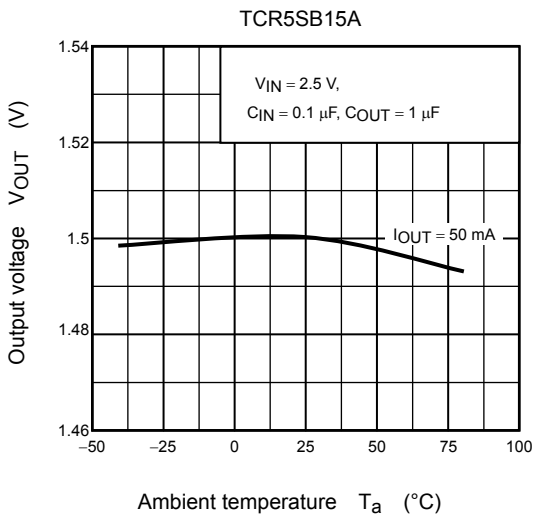

4) Dropout Voltage vs. Output Current

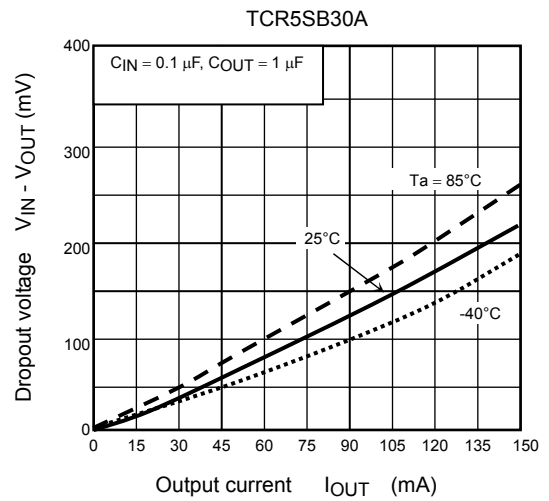
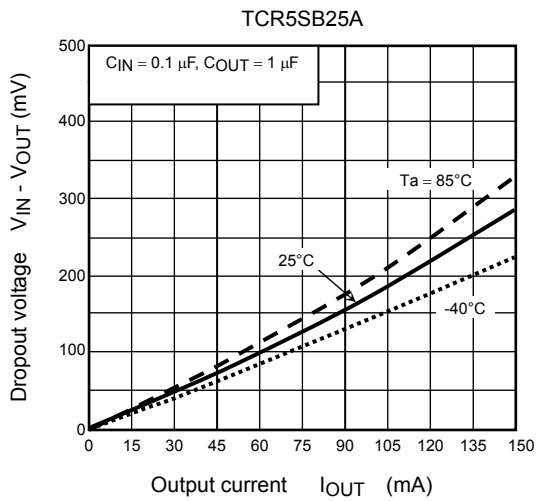

5) Quiescent Current vs. Input Voltage

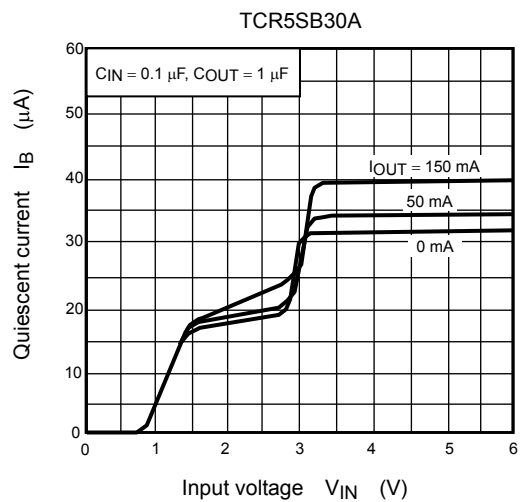
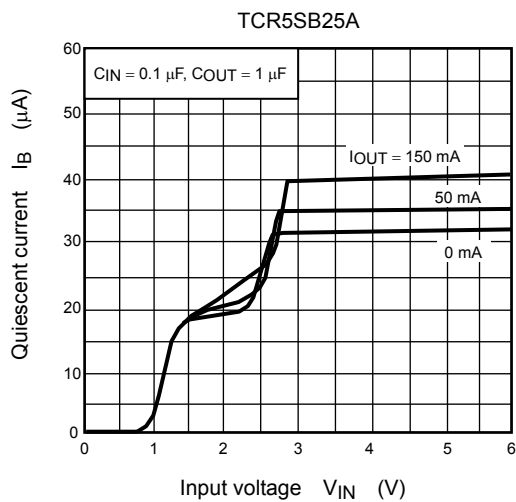
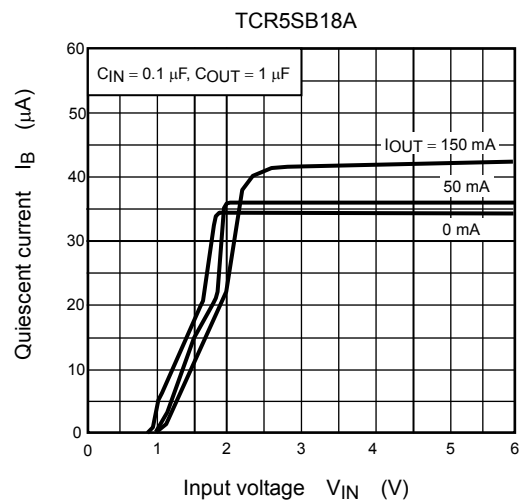
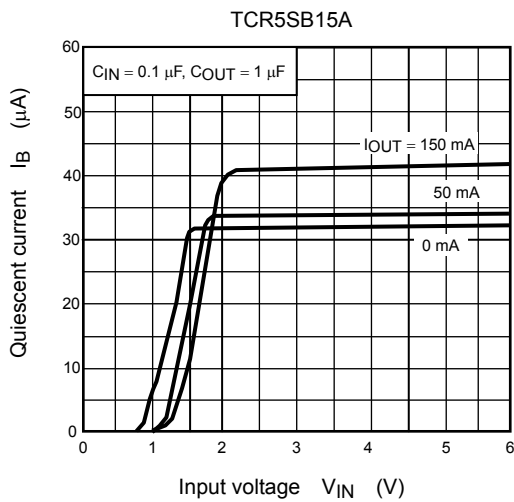

6) Quiescent Current vs. Ambient temperature

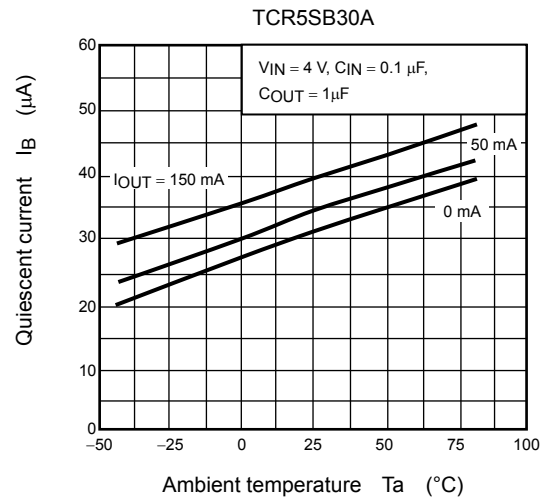
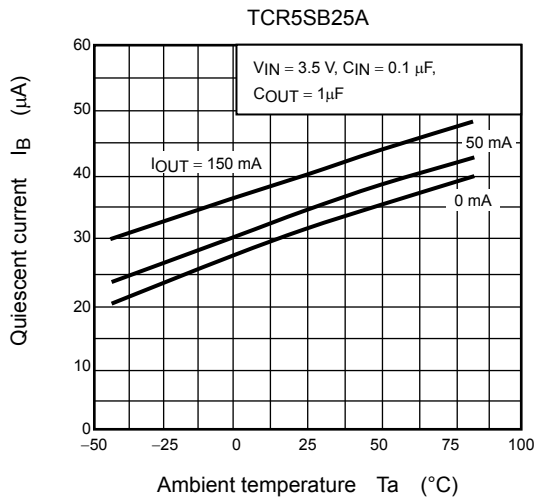
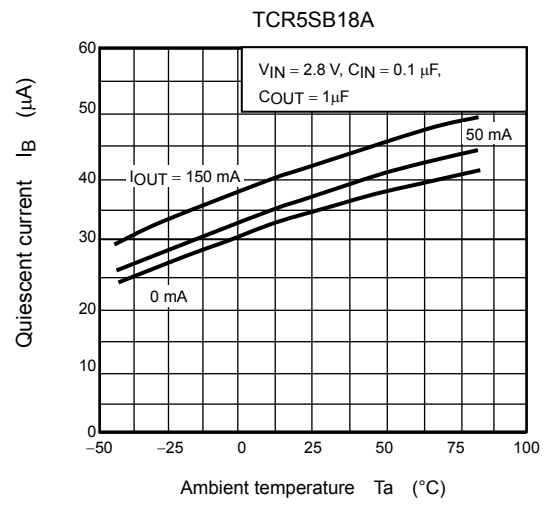
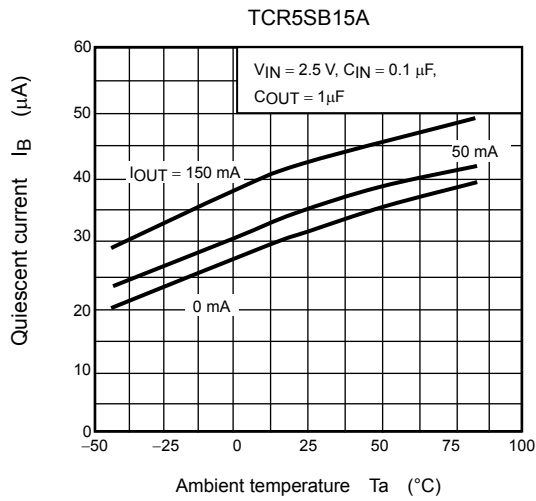

7) Overcurrent Protection Characteristics

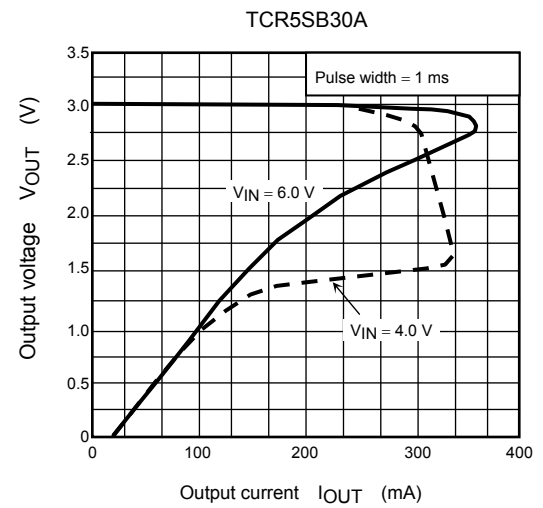
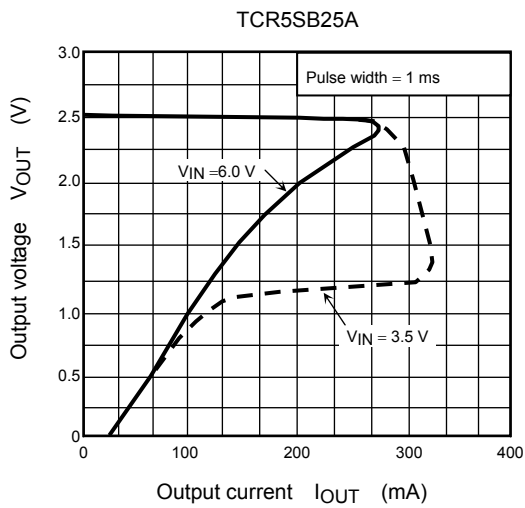
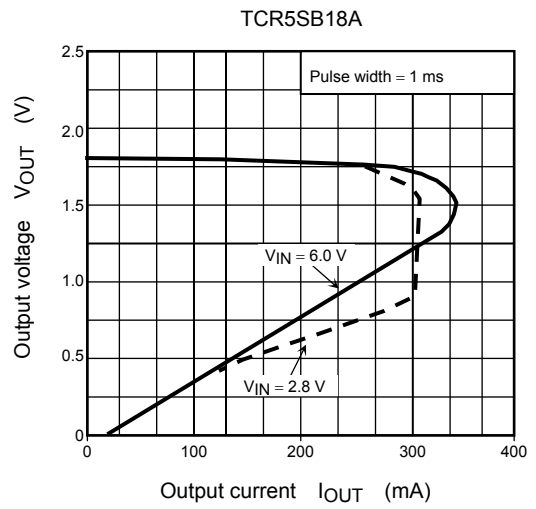
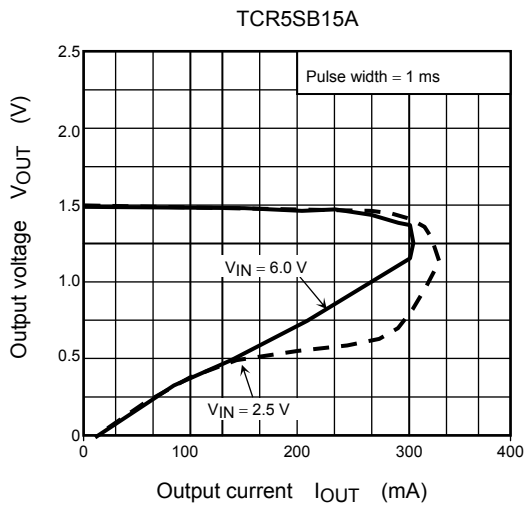

8) Ripple rejection Ratio vs. Frequency (Dependence of Capacitors)

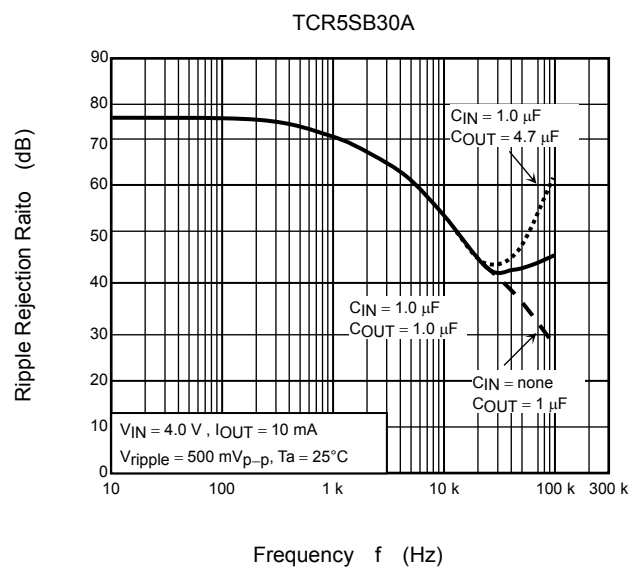

10) Control Transient Response

TCR5SB15A (Turn on wave form)

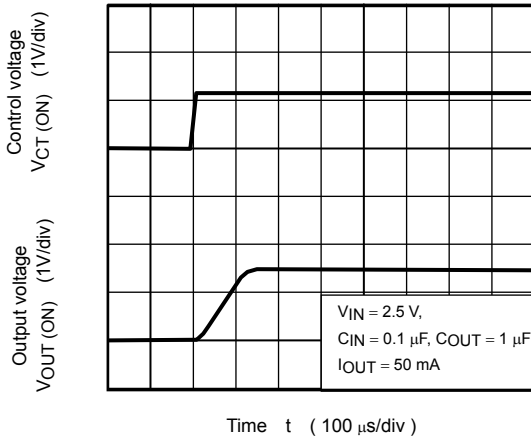

TCR5SB15A (Turn off wave form)

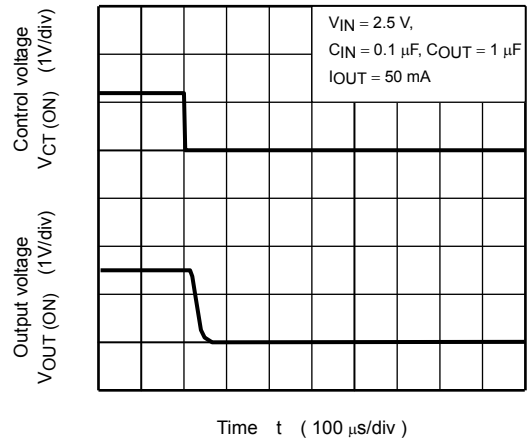

TCR5SB18A (Turn on wave form)

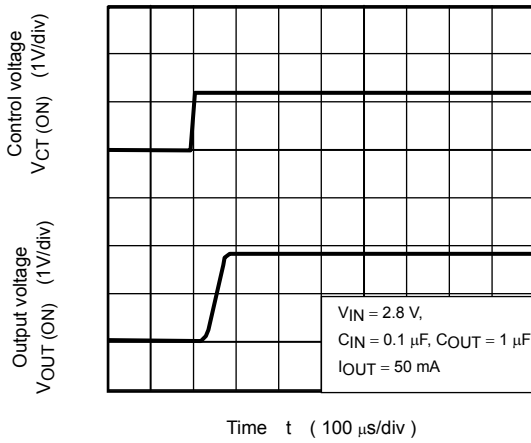

TCR5SB18A (Turn off wave form)

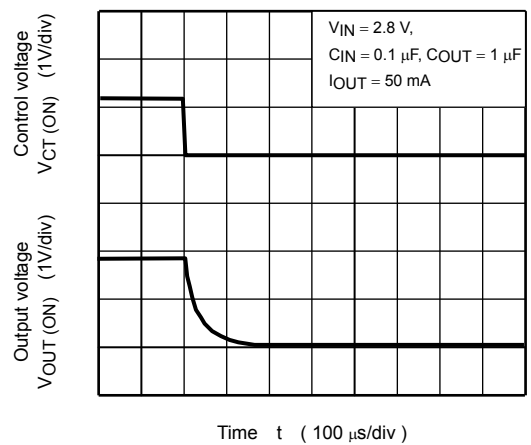

TCR5SB30A (Turn on wave form)

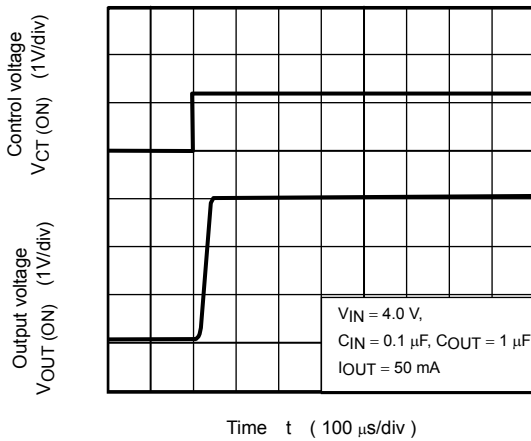

TCR5SB30A (Turn off wave form)

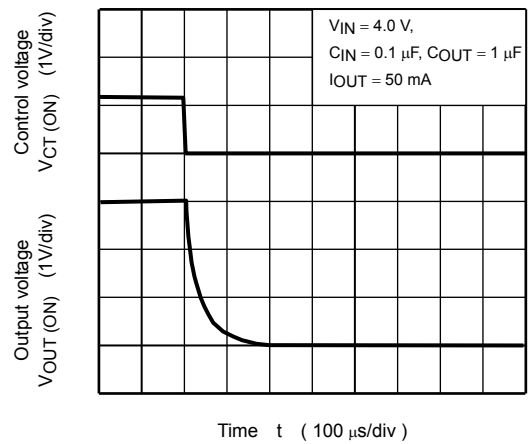

11) Load Transient Response

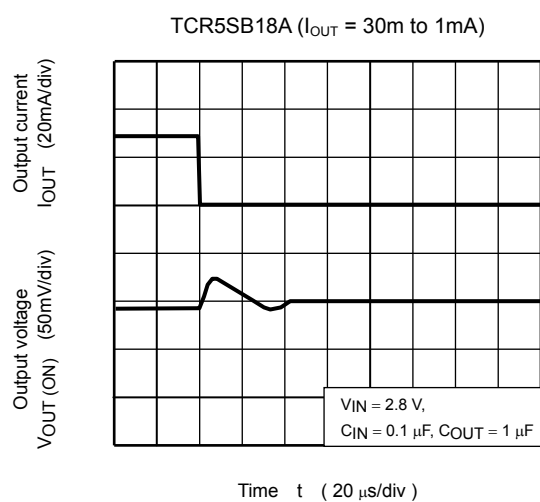
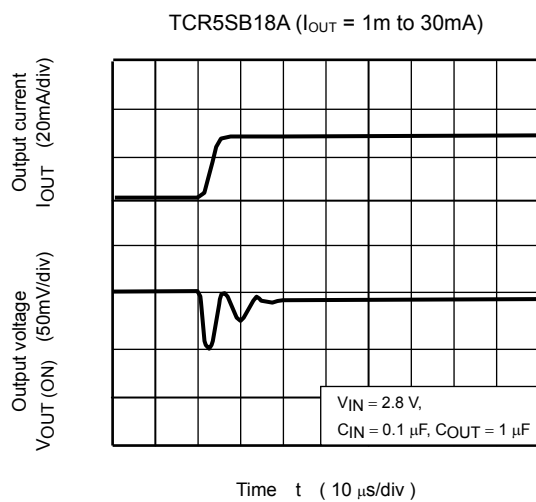
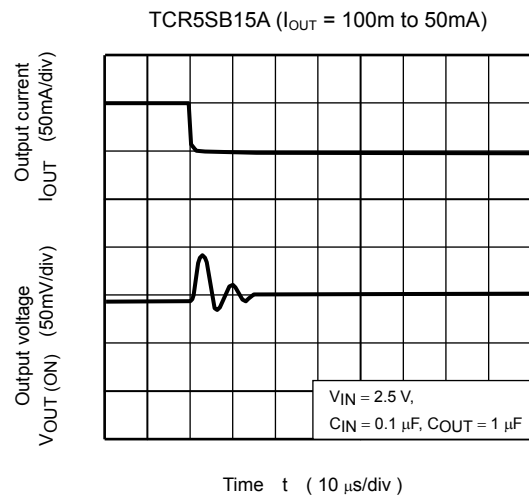
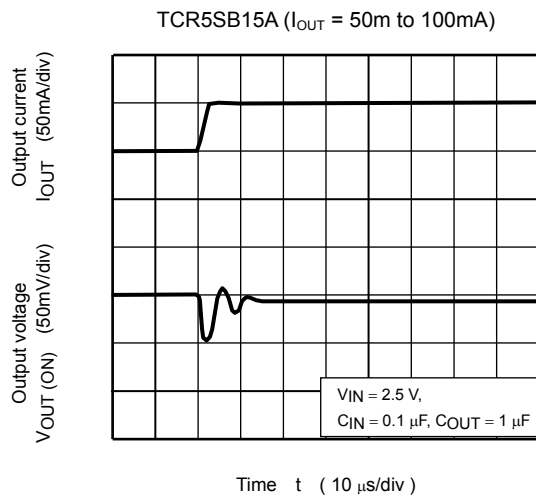
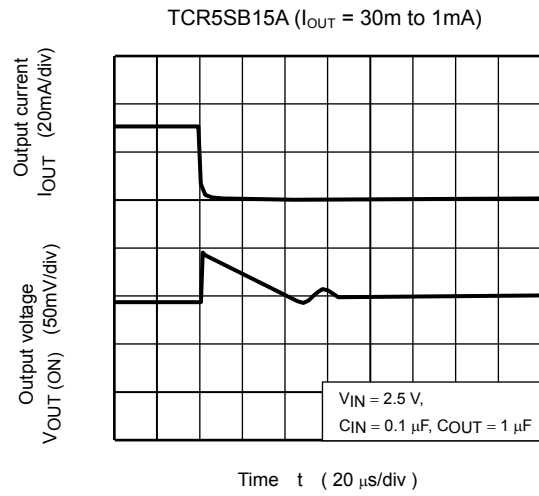
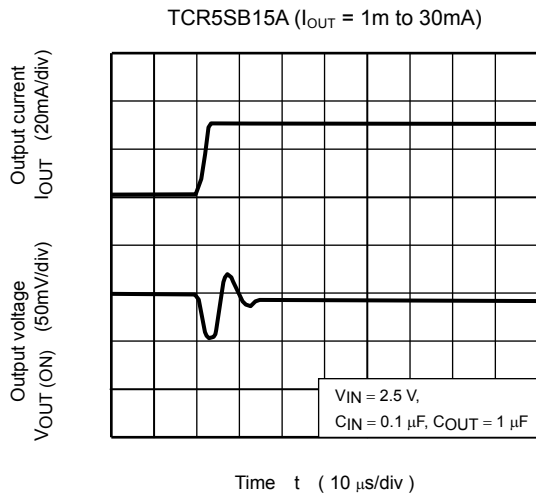

TCR5SB18A ($I_{OUT} = 50\text{m to }100\text{mA}$)

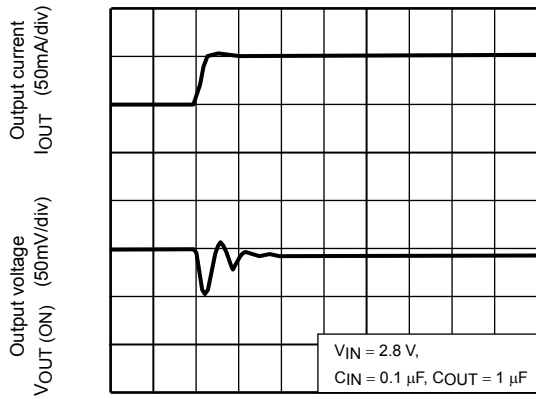

Time t (10 $\mu\text{s/div}$)

TCR5SB18A ($I_{OUT} = 100\text{m to }50\text{mA}$)

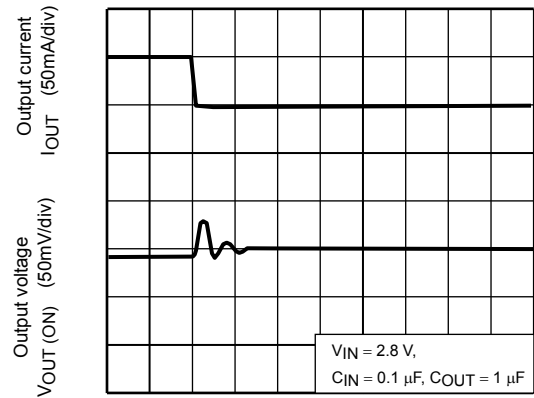

Time t (10 $\mu\text{s/div}$)

TCR5SB30A ($I_{OUT} = 1\text{m to }30\text{mA}$)

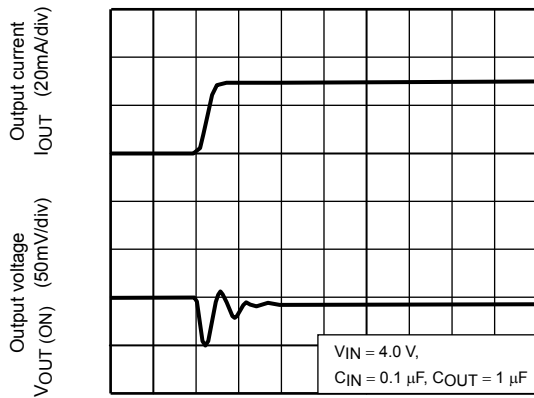

Time t (10 $\mu\text{s/div}$)

TCR5SB30A ($I_{OUT} = 30\text{m to }1\text{mA}$)

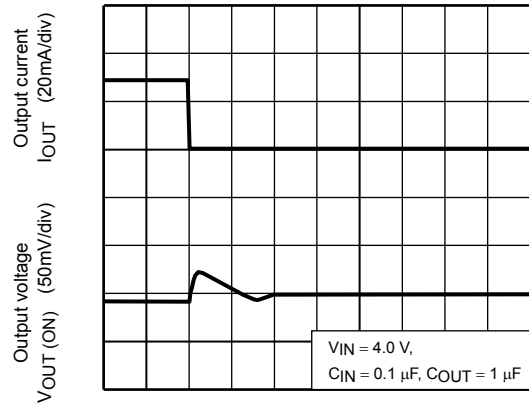

Time t (20 $\mu\text{s/div}$)

TCR5SB30A ($I_{OUT} = 50\text{m to }100\text{mA}$)

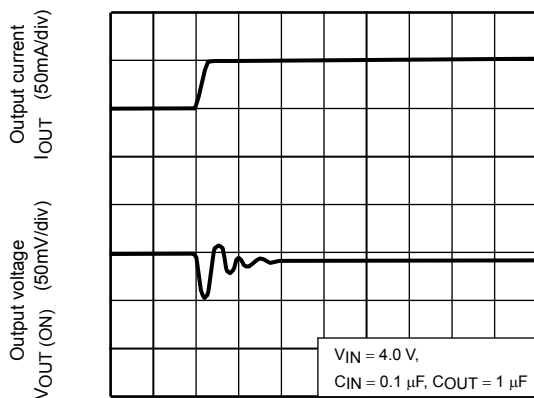

Time t (10 $\mu\text{s/div}$)

TCR5SB30A ($I_{OUT} = 100\text{m to }50\text{mA}$)

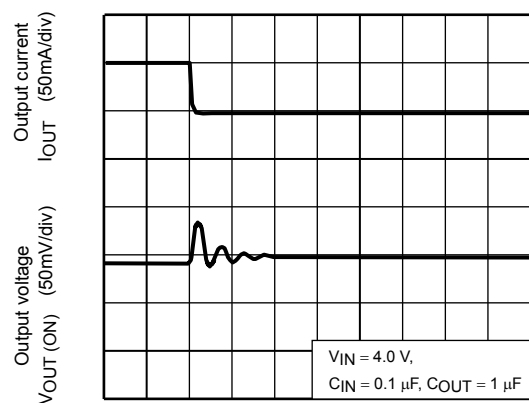

Time t (10 $\mu\text{s/div}$)

Package Dimensions

SSOP5-P-0.95

Unit : mm

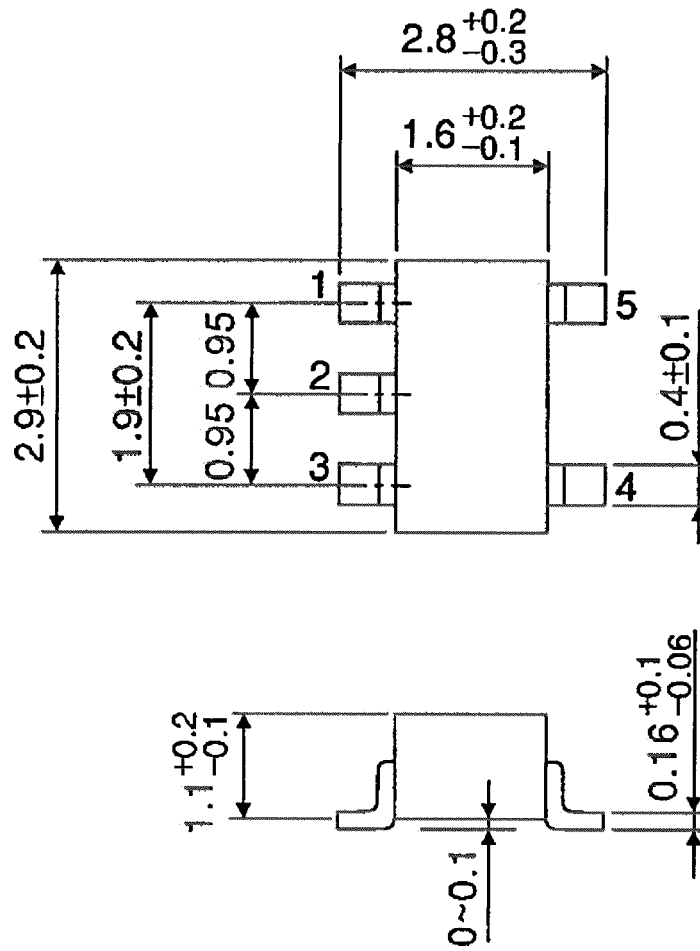

Weight: 0.016 g (typ)

RESTRICTIONS ON PRODUCT USE

20070701-EN GENERAL

- The information contained herein is subject to change without notice.
- TOSHIBA is continually working to improve the quality and reliability of its products. Nevertheless, semiconductor devices in general can malfunction or fail due to their inherent electrical sensitivity and vulnerability to physical stress. It is the responsibility of the buyer, when utilizing TOSHIBA products, to comply with the standards of safety in making a safe design for the entire system, and to avoid situations in which a malfunction or failure of such TOSHIBA products could cause loss of human life, bodily injury or damage to property.
In developing your designs, please ensure that TOSHIBA products are used within specified operating ranges as set forth in the most recent TOSHIBA products specifications. Also, please keep in mind the precautions and conditions set forth in the "Handling Guide for Semiconductor Devices," or "TOSHIBA Semiconductor Reliability Handbook" etc.
- The TOSHIBA products listed in this document are intended for usage in general electronics applications (computer, personal equipment, office equipment, measuring equipment, industrial robotics, domestic appliances, etc.). These TOSHIBA products are neither intended nor warranted for usage in equipment that requires extraordinarily high quality and/or reliability or a malfunction or failure of which may cause loss of human life or bodily injury ("Unintended Usage"). Unintended Usage include atomic energy control instruments, airplane or spaceship instruments, transportation instruments, traffic signal instruments, combustion control instruments, medical instruments, all types of safety devices, etc.. Unintended Usage of TOSHIBA products listed in this document shall be made at the customer's own risk.
- The products described in this document shall not be used or embedded to any downstream products of which manufacture, use and/or sale are prohibited under any applicable laws and regulations.
- Please contact your sales representative for product-by-product details in this document regarding RoHS compatibility. Please use these products in this document in compliance with all applicable laws and regulations that regulate the inclusion or use of controlled substances. Toshiba assumes no liability for damage or losses occurring as a result of noncompliance with applicable laws and regulations.